

**Module Characteristics**

<b>Membrane Material</b>		<b>PDMS ( Silicone )</b>
<b>Membrane Type</b>		<b>Dense Hollow Fiber</b>
<b>Fiber ID</b>	mm (in)	<b>190 ( 0.00748 )</b>
<b>Fiber OD</b>	mm (in)	<b>300 ( 0.0118 )</b>
<b>Fiber Wall Thickness</b>	mm (in)	<b>55 ( 0.0022 )</b>
<b>Fiber Count</b>	#	<b>3200</b>
<b>Membrane Area<sup>1</sup></b>	cm <sup>2</sup> (ft <sup>2</sup> )	<b>2500 ( 2.69 )</b>
<b>Module Length</b>	cm (in)	<b>14 ( 5.5 )</b>
<b>Module Diameter</b>	cm (in)	<b>3.5 ( 1.375 )</b>
<b>Fittings / Connection Size</b>	in	<b>Barbed 1/4</b>
<b>Shell / End Caps</b>		<b>Polycarbonate</b>
<b>Fittings Material</b>		<b>Polycarbonate</b>
<b>Potting Material</b>		<b>Polyurethane</b>
<b>Other Materials of Construction<sup>2</sup></b>		<b>Polypropylene, Acrylic</b>

**Operating Conditions**

<b>Max Continuous Operating Temperature</b>	°C (°F)	<b>60 ( 140 )</b>
<b>Max Shell Side Pressure</b>	bar (psia)	<b>3 ( 45 ) @ 77°F</b>
<b>Max Lumen Pressure</b>	bar (psia)	<b>3 ( 45 ) @ 77°F</b>
<b>Max TMP<sup>3</sup> Shell to Lumen</b>	bar (psi)	<b>1 ( 15 ) @ 77°F</b>
<b>Max TMP<sup>3</sup> Lumen to Shell</b>	bar (psi)	<b>3 ( 45 ) @ 77°F</b>
<b>Typical Liquid Flow Rate</b>	l/min (gpm)	<b>0.2 - 1.9 ( 0.05 - 0.5 )</b>
<b>Sweep Flow Rate (no Vacuum)</b>	scfm (slpm)	<b>0.02 - 0.2 ( 0.5 - 6 )</b>
<b>Sweep Flow Rate with Vacuum</b>	scfm (slpm)	<b>0.004 - 0.04 ( 0.1 - 1.2 )</b>
<b>Typical Gas Flow Rate</b>	scfm (slpm)	<b>0.004 - 0.4 ( 0.1 - 12 )</b>

**Volume / Weight**

<b>Lumen Side Priming Volume</b>	ml	<b>21</b>
<b>Shell Side Priming Volume</b>	ml	<b>26</b>
<b>Dry Weight</b>	lbs (g)	<b>0.19 ( 86 )</b>
<b>Wet Weight - Shell Side Filled</b>	lbs (g)	<b>0.25 ( 112 )</b>
<b>Shipping Weight</b>	lbs (g)	<b>0.23 ( 105 )</b>

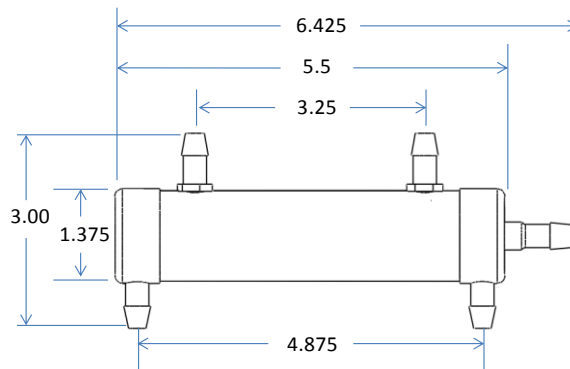

Note: All dimensions in inches

1- Based on fiber OD  
 2- Traces of PVOH (polyvinyl alcohol) possible in lumens  
 3- TMP (Transmembrane Pressure)

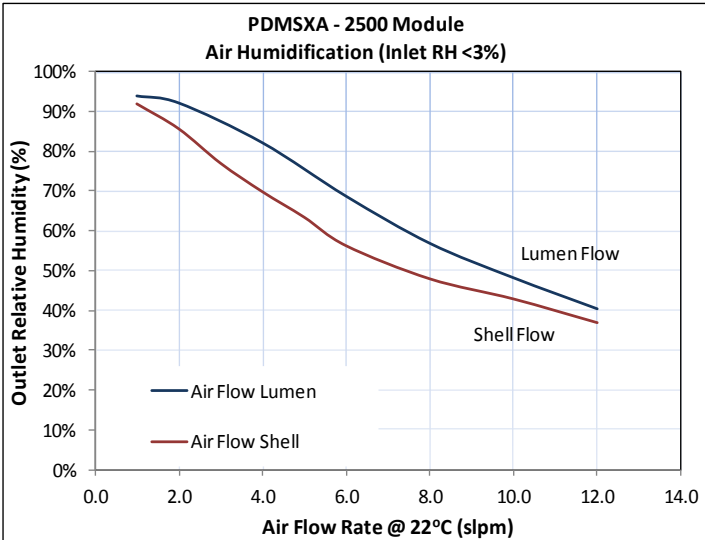
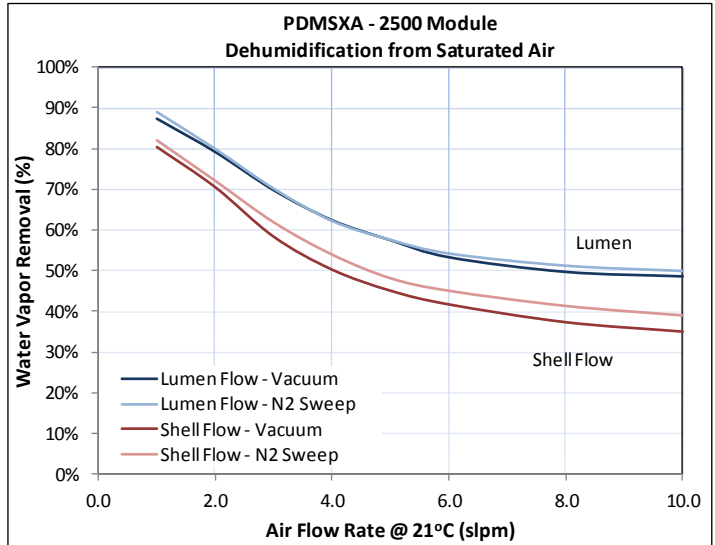
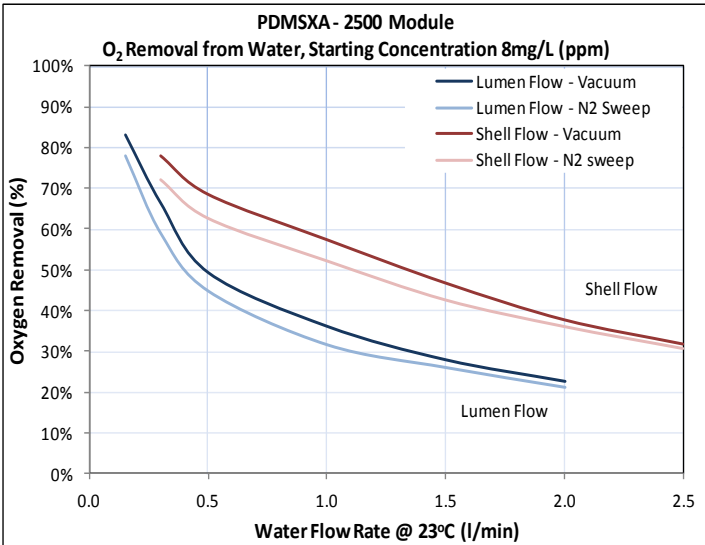
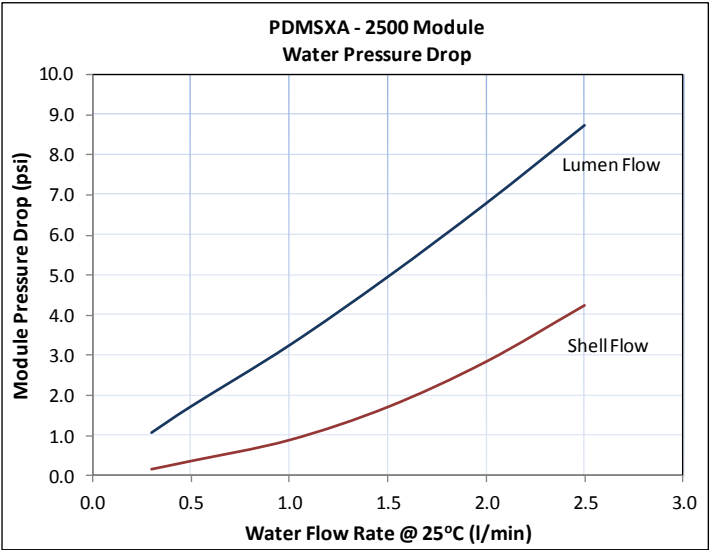
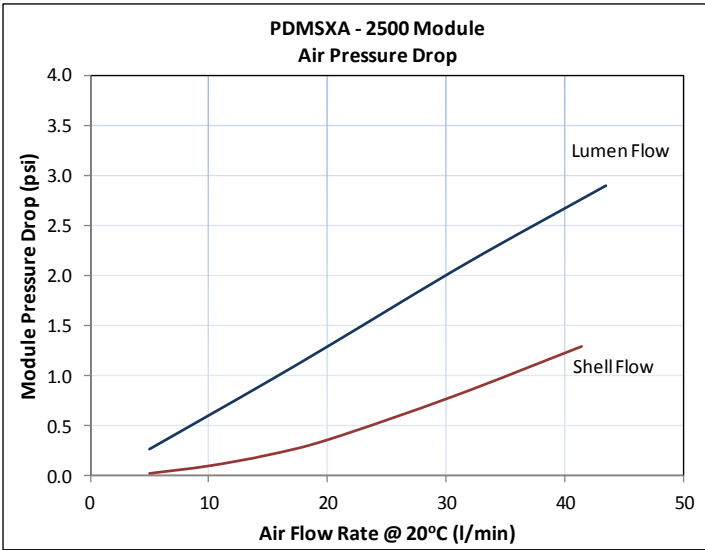
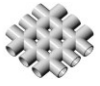

This product is to be used only by persons familiar with its use. It is the responsibility of the user to determine the suitability of PermSelect® membrane modules in its specific application. Membrane modules can fail, permitting fluid discharge into the environment and mixing of shell and tube side fluids. **Users must take all precautions to ensure safety to people and property in case of module failure.** Purchaser assumes all responsibility for the suitability and fitness for use as well as for the protection of the environment and for health and safety involving this product. Seller reserves the right to modify this document without prior notice. Check our web site to verify the latest update. To the best of our knowledge the information contained herein is accurate. However, neither MedArray, Inc. nor any of its affiliates assumes any liability whatsoever for the accuracy or completeness of the information contained herein. Final determination of the suitability of any material and whether there is any infringement of patents, trademarks, or copyrights is the sole responsibility of the user. Users of any substance with PermSelect® membrane modules should satisfy themselves by independent investigation that the material can be used safely. We may have described certain hazards, but we cannot guarantee that these are the only hazards that exist.

PermSelect® is a registered trademark of MedArray, Inc., 3915 Research Park Dr., Ste. A-4, Ann Arbor, MI 48108; +1 (734) 769-1066; www.permselect.com. PermSelect® membranes and membrane modules are protected by US and international patents.