

Module Characteristics

Membrane Material		PDMS (Silicone)
Membrane Type		Dense Hollow Fiber
Fiber ID	µm (in)	190 (0.00748)
Fiber OD	µm (in)	300 (0.0118)
Fiber Wall Thickness	µm (in)	55 (0.0022)
Fiber Count	#	30000
Membrane Area ¹	m ² (ft ²)	2.1 (22.6)
Module Length	cm (in)	14.2 (5.6)
Module Diameter	cm (in)	8.9 (3.5)
Fittings / Connection Size	in	Barbed 1/4 and 3/8
Shell / End Caps		Polycarbonate / PVC
Fittings Material		Polypropylene
Potting Material		Polyurethane
Other Materials of Construction ²		Polypropylene, Acrylic

Operating Conditions

Max Continuous Operating Temperature	°C (°F)	60 (140)
Max Shell Side Pressure	bar (psig)	1 (15) @ 77°F
Max Lumen Pressure	bar (psig)	2 (30) @ 77°F
Max TMP ³ Shell to Lumen	bar (psi)	1 (15) @ 77°F
Max TMP ³ Lumen to Shell	bar (psi)	3 (45) @ 77°F
Typical Liquid Flow Rate	l/min (gpm)	2.75 - 19 (0.75 - 5)
Sweep Flow Rate (no Vacuum)	scfm (slpm)	0.2 - 1 (5 - 30)
Sweep Flow Rate with Vacuum	scfm (slpm)	0.04 - 0.2 (1 - 6)
Typical Gas Flow Rate	scfm (slpm)	0.04 - 2.0 (1 - 60)

Volume / Weight

Lumen Side Priming Volume	ml	205
Shell Side Priming Volume	ml	190
Dry Weight	lbs (g)	1.05 (475)
Wet Weight - Shell Side Filled	lbs (g)	1.44 (655)
Shipping Weight	lbs (g)	1.25 (567)

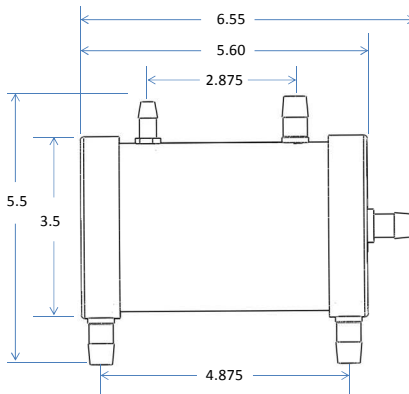

Note: All dimensions in inches

1- Based on fiber OD
 2- Traces of PVOH (polyvinyl alcohol) possible in lumens
 3- TMP (Transmembrane Pressure)

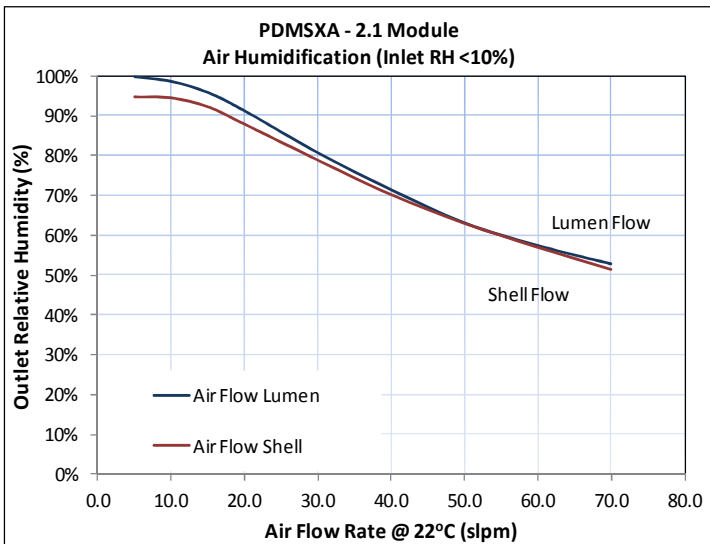
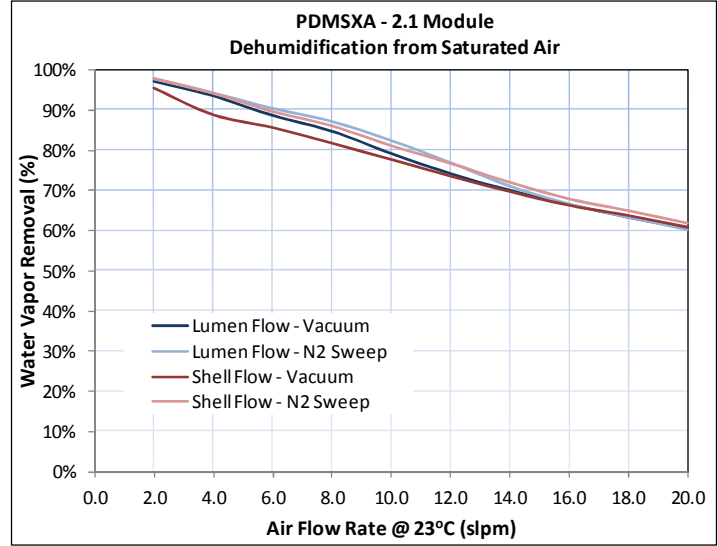
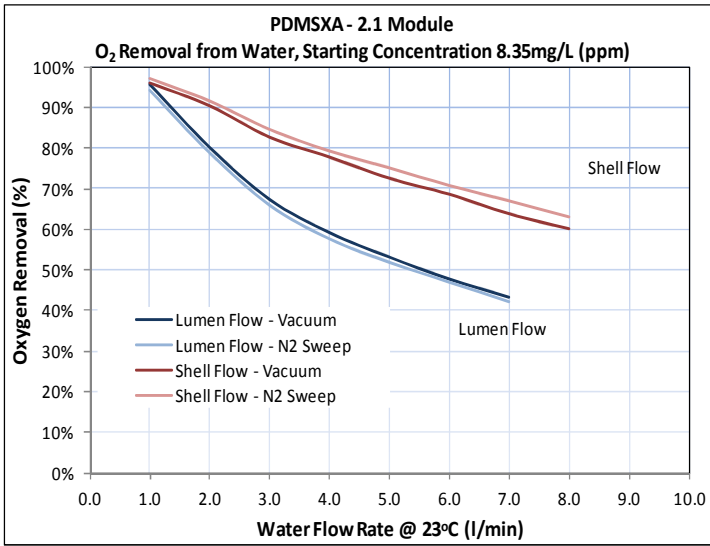
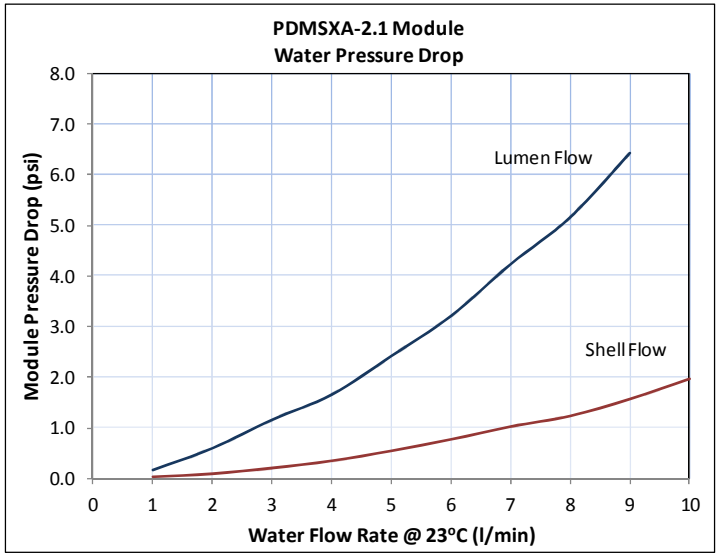
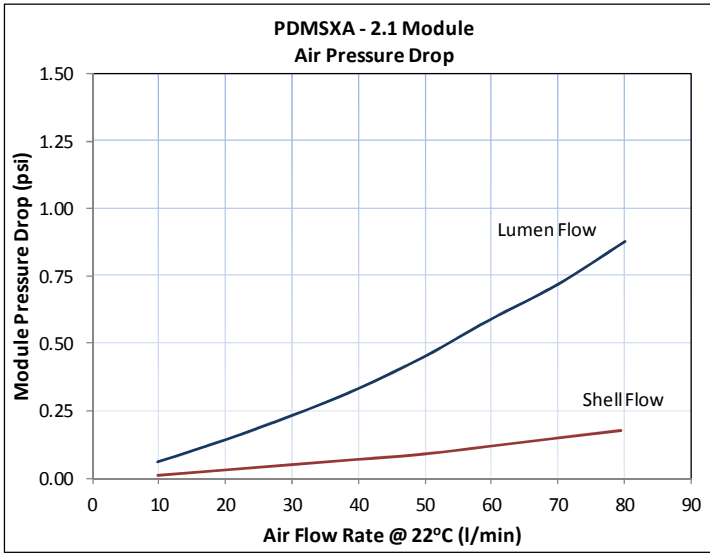
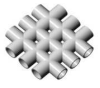

This product is to be used only by persons familiar with its use. It is the responsibility of the user to determine the suitability of PermSelect® membrane modules in its specific application. Membrane modules can fail, permitting fluid discharge into the environment and mixing of shell and tube side fluids. **Users must take all precautions to ensure safety to people and property in case of module failure.** Purchaser assumes all responsibility for the suitability and fitness for use as well as for the protection of the environment and for health and safety involving this product. Seller reserves the right to modify this document without prior notice. Check our web site to verify the latest update. To the best of our knowledge the information contained herein is accurate. However, neither MedArray, Inc. nor any of its affiliates assumes any liability whatsoever for the accuracy or completeness of the information contained herein. Final determination of the suitability of any material and whether there is any infringement of patents, trademarks, or copyrights is the sole responsibility of the user. Users of any substance with PermSelect® membrane modules should satisfy themselves by independent investigation that the material can be used safely. We may have described certain hazards, but we cannot guarantee that these are the only hazards that exist.

PermSelect® is a registered trademark of MedArray, Inc., 3915 Research Park Dr., Ste. A-4, Ann Arbor, MI 48108; +1 (734) 769-1066; www.permselect.com. PermSelect® membranes and membrane modules are protected by US and international patents.

PDMSXA-2.1-17-09